

# Specials

January-February 2012

Phone 02 9548 4888 Free Call 1800 101 009 Website [www.furnware.net.au](http://www.furnware.net.au)

## Welcome Back

We'd like to take this opportunity once again, to thank you for your support during the past year. We look forward to the year ahead, and we trust that we can continue to be of service to you throughout 2012.

Please take a moment of your valuable time to peruse our latest specials and new products release brochure. With great prices on a selection of our vast range and many new items being released, we look forward to hearing from you soon.

The Furnware Team

NOV  
Issue 1  
NOV



**Or a pair of Furnware picnic chairs  
with every order over the value of \$750**

- \* Please quote part number WBQ100 to receive your free Weber Baby Q.
- \* Please quote part number FPC02 to receive your free Picnic Chairs.
- \* \$3000 & \$750 is goods value - does not include freight or GST.
- \* Spend amount must be reached in one invoice.
- \* Offer only applies to goods ordered from this brochure.
- \* Offer valid until 29.2.12 or while stocks last.
- \* Limit 1 per customer.



**furnware**  
CABINET HARDWARE SPECIALISTS

## We have *moved!*

- Bigger premises
- Strategic location
- Faster despatch
- Larger stocks
- Furnware - *1st in Service!*



Our Warehouse, Despatch and Trade Counter are moving to bigger premises to provide our valued customers with even greater service. Our new warehouse is four times the size of our current location, and being strategically located to enhance our level of service, the team at Furnware is excited about this move forward as we strive to exceed the expectations of our customers.

**New Address:** 1-5 Jessica Place, Prestons NSW 2170.

Please note that as of 9th January 2012, our Warehouse, Despatch and Trade counter will be located at this new address. Our Administration and Sales team remain at 18 Burns Road, Heathcote NSW 2233.

Our Trade counter at Heathcote is closing.

Please note that our telephone, fax and email details remain the same.

The Furnware Team





## Trianon Collection

- Material: Porcelain & Zinc Alloy
- Available in 3 finishes:
  - Cream Crackle & Antique Brass
  - White Crackle & Pewter
  - White & Brushed Nickel

See our 2012 Catalogue Section A. Handles & Knobs showcasing our complete range of contemporary & traditional styles!



Cream Crackle & Antique Brass



White Crackle & Pewter

White & Brushed Nickel



### Trianon Collection

Code	Part No.	Finish	C mm	OL mm	P mm	D mm	Price 25	Price ea	Per
A	TCM3620	CRCRAB, WHCRPW, WHBRN	-	-	32	35	4.70	6.11	ea
B	TCM3621	CRCRAB, WHCRPW, WHBRN	-	90	42	-	9.45	12.28	ea
C	TCM3622	CRCRAB, WHCRPW, WHBRN	128	154	40	-	15.90	20.67	ea
D	TCM3623.224	CRCRAB, WHCRPW, WHBRN	224	245	63	-	17.95	23.33	ea
E	TCM3623.320	CRCRAB, WHCRPW, WHBRN	320	345	63	-	21.60	28.08	ea

# Specials January - February 2012

Phone 02 9548 4888 Free Call 1800 101 009 Website [www.furnware.net.au](http://www.furnware.net.au)

## NuQueen Undermount Sink & Tap Package

- Overall sink size: 793mm L x 458mm W
- Bowl sizes: 356mm L x 406mm W x 200mm D
- All accessories shown are included in this pack



Part No.	SPECIAL Price	Per
AB.Q200UT	560.00	pk



NuQueen Undermount Package



# Specials January - February 2012

Phone 02 9548 4888 Free Call 1800 101 009 Website [www.furnware.net.au](http://www.furnware.net.au)



## Project Squareline Sink & Tap Package

One & three quarter bowl

- Overall sink size: 1080mm L x 480mm W
- Bowl sizes: 356mm L x 405mm W x 165mm D  
280mm L x 310mm W x 160mm D
- Pack includes 1 sink and 1 tap as shown



Part No.	Description	SPECIAL Price	Per
AB.PR175M35L	Left-hand bowl	199.00	pk
AB.PR175M35R	Right-hand bowl	199.00	pk

Project Squareline Package



We have introduced a large range of Abey Sinkware, that showcases Europe's very best, leading edge designs - practical, affordable, inspirational and stylish.

We stock a stunning range of Sinks & Tapware. See 2012 Catalogue - Section G, for our full range.



Wire-Base  
Baskets



## Slide-out Pantry Units

### MYOH Pull-out Pantry Column - Soft Close

- ✓ Full extension soft close slides
- ✓ Load Rating 90kg
- ✓ Includes 6 fully adjustable chrome plated baskets
- ✓ 5 way door adjustment bracket
- ✓ Minimum internal cabinet depth: 500mm
- ✓ Supplied with assembly instructions
- ✓ Height adjustable: 1900mm - 2200mm
- ✓ Basket height: 80mm
- ✓ Basket depth: 402mm
- ✓ Basket width is 55mm less than cabinet width



Part No.	Cabinet Width* mm	Finish	SPECIAL Price	Regular Price	Per
KFWPSC300	300	CP	318.50	467.10	ea
KFWPSC400	400	CP	333.60	489.28	ea
KFWPSC450	450	CP	336.40	493.31	ea
KFWPSC500	500	CP	347.50	509.44	ea

\*Cabinet Width = External Cabinet Width using 16mm Side Panel

### MYOH Pull-out Pantry Column

- ✓ Full extension slides
- ✓ Load Rating 90kg
- ✓ Includes 6 fully adjustable chrome plated baskets
- ✓ 5 way door adjustment bracket
- ✓ Minimum internal cabinet depth: 500mm
- ✓ Supplied with assembly instructions
- ✓ Height adjustable: 1900mm - 2200mm
- ✓ Basket height: 80mm
- ✓ Basket depth: 402mm
- ✓ Basket width is 55mm less than cabinet width

Part No.	Cabinet Width* mm	Finish	SPECIAL Price	Regular Price	Per
KFWP300	300	CP	279.50	409.98	ea
KFWP400	400	CP	294.60	432.16	ea
KFWP450	450	CP	297.40	436.19	ea
KFWP500	500	CP	308.50	452.32	ea

\*Cabinet Width = External Cabinet Width using 16mm Side Panel



5-way door adjustment bracket



Detail of basket supplied

# Specials January - February 2012

Phone 02 9548 4888 Free Call 1800 101 009 Website [www.furnware.net.au](http://www.furnware.net.au)



## MYOH Pull-out Pantry Column - Soft Close - Solid Base

- ✓ Full extension soft close slides
- ✓ Load Rating 90kg
- ✓ Includes 6 fully adjustable chrome plated baskets with solid HPL base
- ✓ 5 way door adjustment bracket
- ✓ Minimum internal cabinet depth: 500mm
- ✓ Supplied with assembly instructions
- ✓ Height adjustable: 1900mm - 2200mm
- ✓ Basket height: 80mm
- ✓ Basket depth: 402mm
- ✓ Basket width is 55mm less than cabinet width



Solid-Base Baskets

Part No.	Cabinet Width* mm	Finish	SPECIAL Price	Regular Price	Per
KFWPSC300SB	300	CP	321.00	471.16	ea
KFWPSC400SB	400	CP	337.60	495.34	ea
KFWPSC450SB	450	CP	344.50	505.42	ea
KFWPSC500SB	500	CP	365.00	535.66	ea

\*Cabinet Width = External Cabinet Width using 16mm Side Panel

## MYOH Pull-out Pantry Column - Solid Base

- ✓ Full extension slides
- ✓ Load Rating 90kg
- ✓ Includes 6 fully adjustable chrome plated baskets with solid HPL base
- ✓ 5 way door adjustment bracket
- ✓ Minimum internal cabinet depth: 500mm
- ✓ Supplied with assembly instructions
- ✓ Height adjustable: 1900mm - 2200mm
- ✓ Basket height: 80mm
- ✓ Basket depth: 402mm
- ✓ Basket width is 55mm less than cabinet width

Part No.	Cabinet Width* mm	Finish	SPECIAL Price	Regular Price	Per
KFWP300SB	300	CP	282.00	414.04	ea
KFWP400SB	400	CP	299.00	438.22	ea
KFWP450SB	450	CP	305.70	448.30	ea
KFWP500SB	500	CP	326.50	478.54	ea

\*Cabinet Width = External Cabinet Width using 16mm Side Panel



5-way door adjustment bracket



All baskets supplied with solid base as shown

Huge range of Waste Bins available. See Section F. of our 2012 Catalogue!



## Hideaway® Compact Bin

### Range Features:

- Hideaway Compact bins are 'compact' in design making the range ideal for areas with limited space. The units are top mounted and this mounting panel acts as a cover for the bucket/s. One check-out is included in the mounting panel for a replaceable perfume sachet that will assist with unpleasant odours.
- TRACKS - quality ball bearing runners that over extend, allowing easy removal of buckets from beneath the bench top and have a dynamic weight loading of 40kgs.
- METAL GAUGE - 1.0mm Zinc treated steel, powder coated for durability.
- BUCKETS - made from a recyclable, food grade polyethylene plastic. All buckets come complete with a liner holder to hold your bag in place.

### Compact 1 x 15 Litre Bucket

- 260mm W x 310mm H x 360mm D
- 15 litre bucket holds a standard supermarket shopping bag
- Suitable for bathroom vanities and motor homes



Part No.	Description	Finish	SPECIAL Price	Regular Price	Per
KKC15H	Handle pull	WH	125.70	138.27	ea
KKC15D	Drawer pull	WH	135.95	149.55	ea

### Compact 1 x 20 Litre Bucket

- 260mm W x 415mm H x 360mm D
- Ideal for cabinets with limited space



Part No.	Description	Finish	SPECIAL Price	Regular Price	Per
KKC20H	Handle pull	WH	128.25	141.08	ea
KKC20D	Drawer pull	WH	134.60	148.06	ea

### Compact 2 x 15 Litre Buckets

- 300mm W x 310mm H x 510mm D
- 2 x units can be installed within the standard carcass height providing a four bin recycling solution
- 15 litre bucket holds a standard supermarket shopping bag



Part No.	Description	Finish	SPECIAL Price	Regular Price	Per
KKC30H	Handle pull	WH	150.50	165.55	ea
KKC30D	Drawer pull	WH	161.60	177.76	ea

# Specials January - February 2012

Phone 02 9548 4888 Free Call 1800 101 009 Website [www.furnware.net.au](http://www.furnware.net.au)

## Compact 2 x 20 Litre Buckets

- 300mm W x 415mm H x 510mm D
- Ideal recycling solution

Part No.	Description	Finish	SPECIAL Price	Regular Price	Per
KKC40H	Handle pull	WH	153.05	168.36	ea
KKC40D	Drawer pull	WH	165.00	181.50	ea



## Compact 1 x 50 Litre Bucket

- 340mm W x 590mm H x 410mm D
- Ideal for use as a hidden laundry basket
- Suitable for larger family or commercial/office kitchens

Part No.	Description	Finish	SPECIAL Price	Price ea	Per
KKC50H	Handle pull	WH	174.50	191.95	ea
KKC50D	Drawer pull	WH	185.55	204.11	ea



## Flexyled CR

- ✎ Made in Italy
- ✎ Flexible LED strip with self adhesive backing
- ✎ Can be cut shorter, but once cut, further sections cannot be added
- ✎ Innovative connection system allows units of different lengths and corners to be connected in a continuous row
- ✎ Individual LEDs are 7 Lumen each
- ✎ 12 Volt
- ✎ Available in Cool White or Warm White
- ✎ Tough transparent protective resin gives an IP44 rating



Part No.	Light Colour	Length mm	LED's (Watt)	Price 5	Price ea	Per
DFLEXCR.250.WW	Warm White	250	15 (1.20W)	16.35	21.26	ea
DFLEXCR.500.WW	Warm White	500	30 (2.40W)	28.10	36.53	ea
DFLEXCR.1000.WW	Warm White	1000	60 (4.80W)	51.95	67.54	ea
DFLEXCR.CNR.WW	Warm White	50 x 50	6 (0.48W)	9.65	12.55	ea
DFLEXCR.250.CW	Cool White	250	15 (1.20W)	16.35	21.26	ea
DFLEXCR.500.CW	Cool White	500	30 (2.40W)	28.10	36.53	ea
DFLEXCR.1000.CW	Cool White	1000	60 (4.80W)	51.95	67.54	ea
DFLEXCR.CNR.CW	Cool White	50 x 50	6 (0.48W)	9.65	12.55	ea
DFLEXCR.PS	Power supply cord	2000		5.20	6.76	ea
D12.700	12 Volt LED Driver		Max. 12 Watt	30.26	39.34	ea



# Specials January - February 2012

Phone 02 9548 4888 Free Call 1800 101 009 Website [www.furnware.net.au](http://www.furnware.net.au)

Colour Appearance	Cool white	Warm white
Colour Temperature	5000 ÷ 550 ° Kelvin	3000 ÷ 3500 ° Kelvin
Luminous Flux	87.5 lm/W	87.5 lm/W
CRI - Colour Rendering	Ra 70	Ra 70

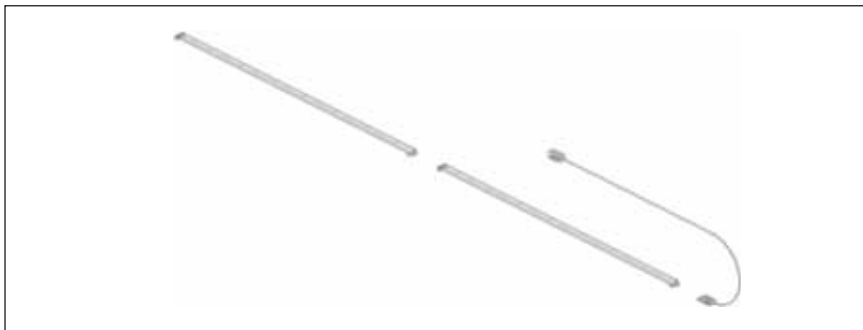
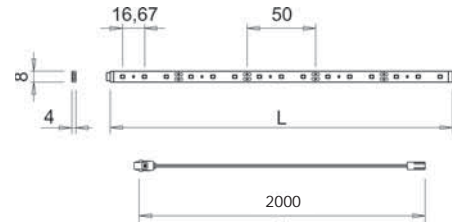

Huge range of Lighting Solutions available. See Section H. of our 2012 Catalogue!

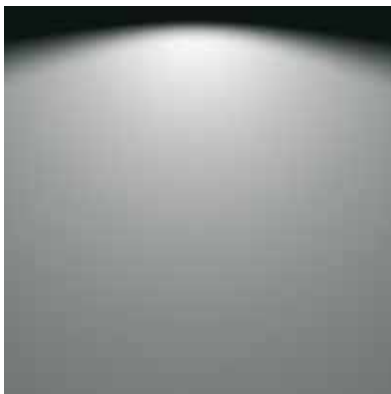

Cool white	5000 ÷ 5500 °K
FLEXYLED CR	flood beam
cm	lux
30	560
50	260

Diagram of a flood beam light showing beam spread at 30cm and 50cm.



Warm white	3000 ÷ 3500 °K
FLEXYLED CR	flood beam
cm	lux
30	420
50	195

Diagram of a flood beam light showing beam spread at 30cm and 50cm.



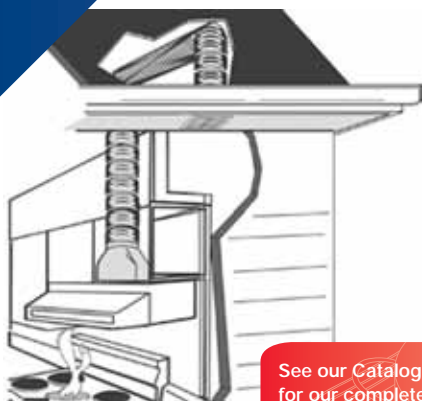

See our Catalogue for our complete range of Ducting!



## Deflect-O Venting Systems

Deflect-O eave venting kits are ideal for ventilation options requiring bends to navigate around obstacles within the roof cavity.

Supplied with the most efficient type of flexible ducting - Semi-rigid aluminium ducting holds its full diameter and form when bent into shape, and also offers a superior temperature range to that of flexible foil type ducting.

Ducting expands to a straight length of 3000mm and should be extended in sections from the centre - out to each end. Refer page F.63 for further details.

The grill vent consists of a calcium filled, polypropylene plastic with UV stabilisers and comes with a removable front grill and mesh for ease of cleaning.

### Deflect-O Rangehood Universal Semi-rigid Kit - Wall/Eave

- ✓ Suits both 125mm or 150mm installations
- ✓ Alternative option to roof penetration - no leaks
- ✓ Effective and unobtrusive
- ✓ Overall maximum length of 3000mm - less with bends
- ✓ Extend reach with additional duct, sleeve and clamps
- ✓ Installation by a professional is recommended

**Kit includes:** DFHGV6 - Grill Vent C/w Screen 150mm  
 DFSRD150.3 - 3000mm Semi-rigid aluminium ducting  
 125mm x 300mm Semi-rigid aluminium ducting  
 DFDIRB65 - 125mm to 150mm Duct increaser  
 DFMC6 - Metal worm drive clamps 150mm  
 DFMC5 - Metal worm drive clamps 125mm

Part No.	SPECIAL Price	Regular Price	Per
DFRHKE65	68.50	98.73	ea



## Deflect-O Layflat Ducting System

Layflat wall venting kits offer a low profile rectangular ducting alternative to standard round aluminium ducting. The Layflat system is ideal for installations with minimal space allowances.

The external dimensions of 210mm L x 66mm W offers greater options to vent in-between floors, wall spaces, or on the top of kitchen cabinets in a smooth, efficient manner that is less conspicuous than other forms of ducting.

The Layflat venting kit is universal allowing it to be used with either 125mm or 150mm venting applications.

For increased safety, the Layflat system is manufactured from white, flame-retardant, self-extinguishing plastic. Installation by a professional is recommended

### Deflect-O Layflat Universal Rangehood Venting Kit - Wall

- ✓ Suits both 125mm or 150mm installations
- ✓ Overall maximum length of 2000mm
- ✓ Shorten ducting length with sharp hacksaw if required
- ✓ Extend reach with additional channel and channel connectors
- ✓ Installation by a professional is recommended

**Kit includes:** DFLFAB.WH - Airbrick (white)  
 DFLF1000.WH - 1.0m Layflat channel (x2)  
 DFLFDC.WH - Channel connector  
 DFLFDS.WH - Channel clip (x2)  
 DFLFWP.WH - Rectangular wall plate  
 DFLFREB.WH - Rotating Elbow Bend 125/150mm  
 150mm x 700mm Semi-Rigid aluminium ducting

Part No.		SPECIAL Price	Regular Price	Per
DFLFWK	WH	167.00	197.51	ea



# Specials January - February 2012

Phone 02 9548 4888 Free Call 1800 101 009 Website [www.furnware.net.au](http://www.furnware.net.au)

## King Slide® Undermount Slide - 34kg Push-to-Open with Soft Close

- Handle-free, push-open
- Enhanced silent soft-closing feature with light opening force
- Durable dampening system with fast response capability
- All mechanical device, instead of electric-driven
- Safe, ergonomic and energy saving
- Under mount with full extension travel length
- Ultra smooth gliding motion with high rigidity and stable design
- 2 dimensional trimming system provides tool-less height and depth adjustments
- Tool-less adjustment system to compensate for minor installation errors
- Effortless assembly and removal of drawer with front release lever
- Lifetime warranty under proper installation and normal usage
- Zinc plated
- 1 pr = 1 drawer



For our full range of Drawer Systems, see our 2012 Catalogue Section B.



Part No.	Length mm	Finish	SPECIAL Price	Price pr	Per
KS34PCU.250	250	ZP	68.45	88.99	pr
KS34PCU.300	300	ZP	70.80	92.04	pr
KS34PCU.350	350	ZP	73.20	95.16	pr
KS34PCU.400	400	ZP	75.55	98.22	pr
KS34PCU.450	450	ZP	77.90	101.27	pr
KS34PCU.500	500	ZP	80.25	104.33	pr
KS34PCU.550	550	ZP	82.60	107.38	pr

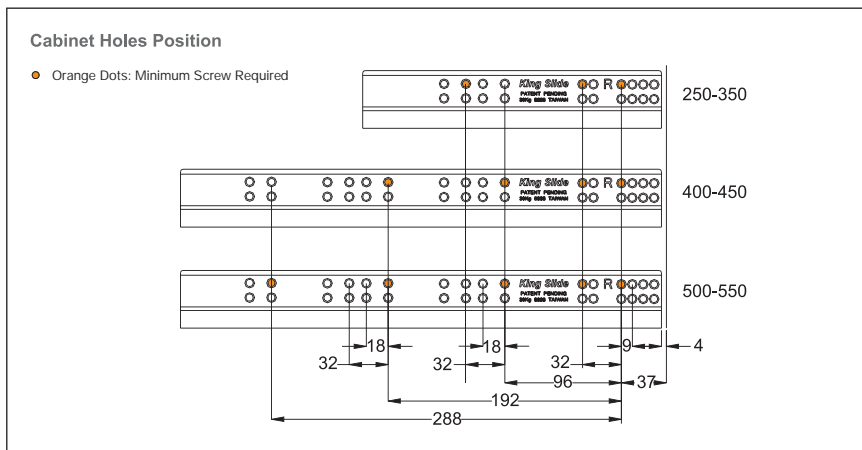
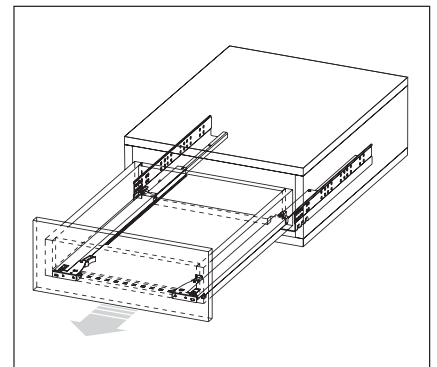

PART NO.	TOTAL LENGTH mm	SLIDE TRAVEL mm	LOADING CAPACITY kg/pair
KS34PCU.250	250	224	34
KS34PCU.300	300	280	34
KS34PCU.350	350	340	34
KS34PCU.400	400	390	34
KS34PCU.450	450	440	34
KS34PCU.500	500	490	34
KS34PCU.550	550	540	34



See our 2012 Catalogue Section K. for our complete range of Wardrobe Fittings!

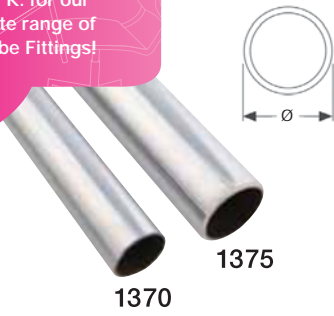

## Wardrobe Tube & Fittings

### Steel Round Tube

Part No.	Ø x L	Material Thickness mm	Finish	SPECIAL Price	Regular Price	Per
1370.3.6	19mm x 3.6m	0.9	CP	8.50	16.44	ea
1375.3.6	25mm x 3.6m	1.2	CP	9.65	22.69	ea

Minimum purchase 10

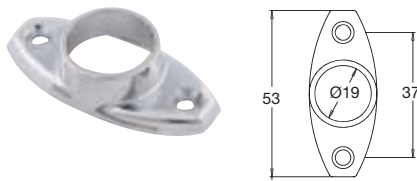

### Flange For Round Tube - 19mm Ø

For 19mm Ø tube

Part No.	Finish	SPECIAL Price	Regular Price	Per
1056	CP	0.65	1.23	ea

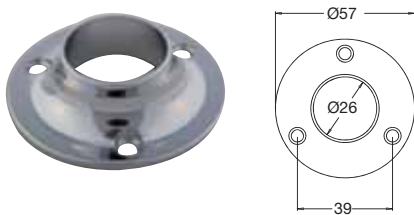

### Flange For Round Tube - 25mm Ø

For 25mm Ø tube

Part No.	Finish	SPECIAL Price	Regular Price	Per
1060	CP	0.76	1.43	ea

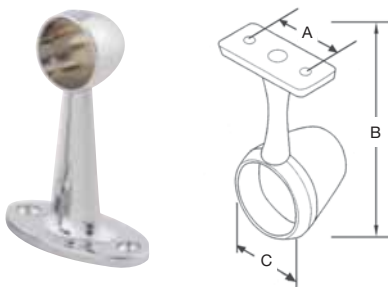

### End Pillar

For round tube

Part No.	A mm	B mm	C mm	Finish	SPECIAL Price	Regular Price	Per
WEP19	37	69	19	CP	0.78	1.43	ea
WEP25	42	81	25	CP	1.30	2.27	ea



### Centre Pillar

For round tube

Part No.	A mm	B mm	C mm	Finish	SPECIAL Price	Regular Price	Per
WCP19	37	69	19	CP	0.78	1.43	ea
WCP25	42	81	25	CP	1.30	2.27	ea

# Specials January - February 2012

Phone 02 9548 4888 Free Call 1800 101 009 Website [www.furnware.net.au](http://www.furnware.net.au)



## Edging

### ABS Satin Un-glued

- Sold by lineal metre
- White only

Part No.	Thickness mm	Width mm	Roll Size m	SPECIAL Price	Regular Price	Per
ABST10U	1	21	200	0.16	0.27	m

Minimum purchase 4 rolls

## White Timber Rail

### Paper Wrap - 2" x 1"

- 2" x 1" (42 x 18mm)
- 3.6 metres long
- 15 per pack
- Paper wrap (Non-shrinking)

Part No.	Finish	SPECIAL Price	Regular Price	Per
TRM36	WH	6.95	12.93	length

Minimum purchase 30 lengths (2 packs)

## Kickboard Material

### Self-adhesive Kickboard Material

- 150mm wide
- 0.3mm thick
- 100m roll
- Minimum order 1 roll

Part No.	Finish	SPECIAL Price	Regular Price	Per
KAS150	BL	92.50	136.63	roll

### Melaplast Metallic Kickboard

- 150mm wide
- 0.6mm thick
- Brushed aluminium or brushed steel finish
- Use contact adhesives to adhere
- Minimum order 1 roll

Part No.	Roll Length m	Finish	Price roll	Per
MKS150.10	10	BA, BRST	175.00	roll
MKS150.25	25	BA, BRST	419.00	roll

## Hot Melt Adhesives

### Hot Melt Glue - Rakoll

- Synthetic hot melt adhesive for edge banding on automatic machines
- Excellent heat resistance up to 65°C
- 15kg Box

Part No.	Description	Colour	SPECIAL Price	Price box	Per
RAK4.570	Granules	NAT	141.70	204.69	box
RAK4.570	Granules	WH	149.20	215.54	box
RAK650.P2	Slugs	NAT	262.00	378.43	box



For our full range of Adhesives, Sealants & Abrasives, see 2012 Catalogue Section N.



## Surface Protection

### Mask 'N' Peel



Mask 'N' Peel IPF127 is a premium protection film with a high level of adhesion. It is used for the protection of melamine doors and panels during painting and other processes. May also be used as a general purpose protection film.

- Thickness: 0.07mm
- Colour: Orange tint

Part No.	Size	SPECIAL Price	Regular Price	Per
IPF127.85	850mm x 100 metre	122.50	141.40	roll
IPF127.122	1200mm x 200 metre	319.00	366.50	roll

### Rout 'N' Peel



Rout 'N' Peel IPF220 is a premium protection film with a high level of adhesion. Used extensively for the protection of melamine and laminates during routing and machining prior to painting. This unique film provides a clean edge during most machining operations. May also serve as a general purpose protection film.

- Thickness: 0.08mm
- Colour: Blue tint

Part No.	Size	SPECIAL Price	Regular Price	Per
IPF220.75	755mm x 100 metre	96.20	112.00	roll
IPF220.122	1220mm x 100 metre	151.00	177.25	roll

### Protect 'N' Peel "Benchtop Saver"



"Benchtop Saver" is a premium protective film which provides temporary surface protection for a wide variety of surfaces. "Benchtop Saver" is suitable for use on some painted finishes, laminates, stone, and fibreglass products, i.e. kitchen benchtops, spa baths etc. Applied to kitchen benchtops after installation "Benchtop Saver" provides protection from damage and the Black/White film gives visual evidence if damage does occur.

- Thickness: 0.12mm
- Colour: Top - White, Adhesive side - Black

Part No.	Size	SPECIAL Price	Regular Price	Per
IPF400	640mm x 100 metre	146.90	170.40	roll

### Aluminium Foil Tape



Designed specifically to provide a heat and moisture barrier for the underneath of benchtops and oven cavities. Aluminium foil tape is ideal for protection from damage and deterioration caused by under-bench ovens and dishwashers. The aggressive adhesive makes IPF830 suitable for most benchtop surfaces including solid timber, chipboard/laminate, solid surface, all stone etc.

- Thickness: 0.2mm (reinforced)
- Colour: Silver

Part No.	Size	SPECIAL Price	Regular Price	Per
IPF830	1000mm x 50 metre	314.60	365.15	roll

# Specials January - February 2012

Phone 02 9548 4888 Free Call 1800 101 009 Website [www.furnware.net.au](http://www.furnware.net.au)



## First Aid Kits

### Class B Kit - Portable

- Tool box style kit
- Suitable for up to 99 people
- Unit size: 200mm x 130mm x 70mm

#### Contents

- 1 x Plastic strip adhesives Pkt/50
- 1 x Adhesive tape 2.5cm x 9m
- 1 x Plastic bags assorted Pkt/3
- 2 x Non-adherent dressings 7.5 x 10cm
- 2 x Eye pads, sterile
- 1 x Conforming bandage 5cm
- 1 x Conforming bandage 10cm
- 2 x Latex gloves Pkt/2
- 1 x Rescue blanket foil
- 1 x Safety pins card of 12
- 1 x Scissors sharp/blunt s/steel 12.5cm
- 1 x Forceps splinter s/steel 12.5cm
- 6 x Eye wash 15ml
- 10 x Antiseptic swabs
- 4 x Triangular bandages 110cm
- 3 x Wound dressings No.15
- 1 x CPR Flowchart
- 1 x First aid instructions pamphlet
- 10 x Antiseptic sterile wipes

Part No.		Price kit	Per kit
FAK.0323		102.12	kit
FAK.0324	Refill kit only	58.61	kit



Safety comes 1st!  
See our full range of Safety Equipment in the 2012 Catalogue Section O.



### Class B Kit - Wall Mountable

- Metal wall mountable cabinet
- Ideal for workshop or construction site use
- Suitable for up to 99 people

#### Contents

- 1 x Plastic strip adhesives Pkt/50
- 1 x Adhesive tape 2.5cm x 9m
- 1 x Plastic bags assorted Pkt/3
- 2 x Non-adherent dressings 7.5 x 10cm
- 2 x Eye pads, sterile
- 1 x Conforming bandage 5cm
- 1 x Conforming bandage 10cm
- 2 x Latex gloves Pkt/2
- 1 x Rescue blanket foil
- 1 x Safety pins card of 12
- 1 x Scissors sharp/blunt s/steel 12.5cm
- 1 x Forceps splinter s/steel 12.5cm
- 6 x Eye wash 15ml
- 10 x Antiseptic swabs
- 4 x Triangular bandages 110cm
- 3 x Wound dressings No.15
- 1 x CPR Flowchart
- 1 x First aid instructions pamphlet

Part No.		Price kit	Per kit
FAK.0325		136.90	kit
FAK.0326	Refill kit only	58.61	kit



### Cobra Safety Glasses

- Conforms to AS/NZS1337
- Clear

Part No.	SPECIAL Price	Regular Price	Per
SG6701.CL	6.10	9.36	pr

Minimum purchase 6



### Disposable Earplugs

- Class 5
- Conforms to AS/NZS1270
- SLC80 Rating - 27dB
- Soft foam conical earplugs
- Box of 200 pairs

Part No.	SPECIAL Price	Regular Price	Per
EAR68	39.00	62.66	box

Minimum purchase 1 box



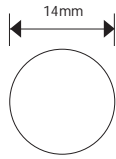

## 14mm Self Adhesive Covers

- ✎ Colours as per opposite page
- ✎ 25 Covers per sheet

Part No.	Price 10 sheets	Price sheet	Per
CSA14.----	1.25	1.63	sheet

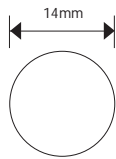

## 14mm Metallic Self Adhesive Covers

- ✎ Colours as per opposite page
- ✎ Aluminium material
- ✎ 25 Covers per sheet

Part No.	Price 10 sheets	Price sheet	Per
CSA14.----	4.10	5.33	sheet

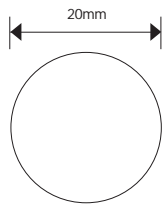

## 20mm Self Adhesive Covers

- ✎ Colours as per opposite page
- ✎ 15 Covers per sheet

Part No.	Price 10 sheets	Price sheet	Per
CSA20.----	1.10	1.43	sheet

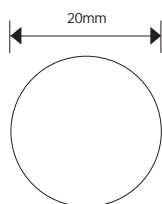

## 20mm Metallic Self Adhesive Covers

- ✎ Colours as per opposite page
- ✎ Aluminium material
- ✎ 15 Covers per sheet

Part No.	Price 10 sheets	Price sheet	Per
CSA20.----	4.05	5.27	sheet

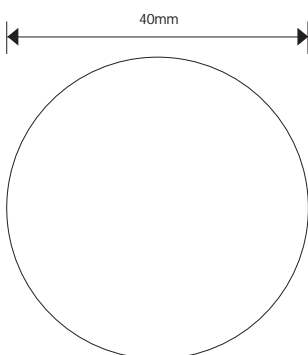

## 40mm Self Adhesive Covers

- ✎ White satin and paintable only
- ✎ 4 Covers per sheet

Part No.	Price 10 sheets	Price sheet	Per
CSA40	1.75	2.28	sheet

# Specials January - February 2012

Phone 02 9548 4888 Free Call 1800 101 009 Website [www.furnware.net.au](http://www.furnware.net.au)

## Colour Chart

### Standard Colours



See our full range of Fasteners & Accessories in the 2012 Catalogue Section M.



### Paintable

- Can be painted any finish
- Supplied ready to paint

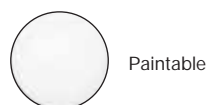

### Metallic Colours





## Have you received our 2012 Product Selection Guide?

Furnware's 2012 Product Selection Guide a must for all:

- ✓ Cabinetmakers
- ✓ Kitchen Manufacturers
- ✓ Furniture Manufacturers
- ✓ Joiners
- ✓ Shop Fitters
- ✓ Architects & Designers

We are pleased to announce the release of our latest catalogue showcasing our complete range of over 7,000 products. We are excited about the many new & innovative products that we have added to our already comprehensive range of cabinet hardware. Our products are continually being evaluated and improved to take the lead in our ever progressing market.

Once again, we have applied our Easy-to-read principle to the catalogue and being fully priced, this catalogue is a must have for every cabinet maker.

We are currently distributing these catalogues so keep an eye out for your copy.

### The Furnware Team

**NEW** Website coming soon!



Full catalogue on CD now available!

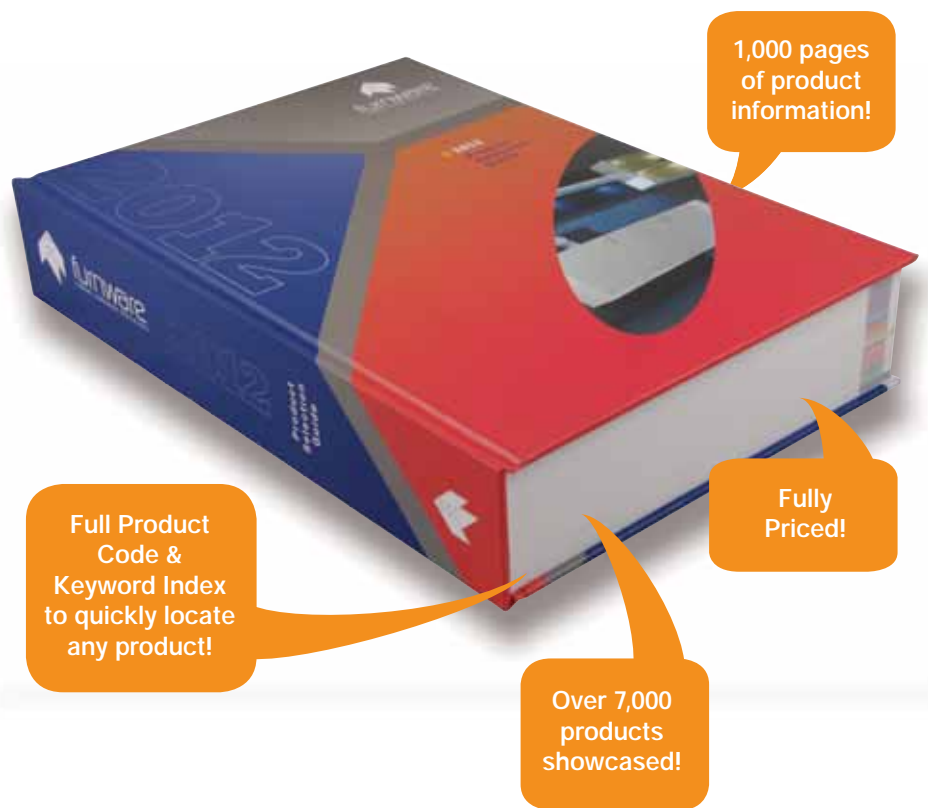

Phone 02 9548 4888

Fax 02 9548 6191

Email [sales@furnware.net.au](mailto:sales@furnware.net.au)

Website [www.furnware.net.au](http://www.furnware.net.au)

Postal PO Box 250 Engadine NSW 2233

Head Office 18 Burns Road Heathcote NSW 2233

Warehouse & Showroom 1-5 Jessica Place, Prestons NSW 2170