



A close-up photograph of a white plastic roller mounted on a metal track. The track has several oval-shaped holes. A semi-transparent purple rectangular box is overlaid on the right side of the image, containing the text 'B. Drawer Systems'.

B. Drawer Systems



Drawer Systems - Contents

EUROTEK DRAWER SLIDES	B.3-B.4	
HEAVY DUTY DRAWER SLIDES	B.5	
WARDROBE BASKETS	B.6	
CONCEALED SOFT-CLOSE SLIDE	B.7-B.8	
EUROTEK WARDROBE DRAWER	B.9	
FILE DRAWER ACCESSORIES	B.10	



METAL DRAWER SLIDES

Bottom mount - Self closing
Bulk packed - 25kg Load rating
1 Set = 1 Drawer

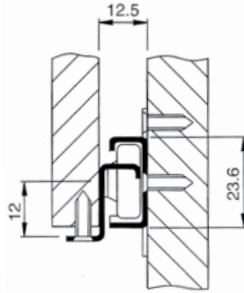

Part No.	Slide Length	Finish	Price 250	Price 25	Price Set	per
MDR250	250	WH, BL, BR				set
MDR300	300	WH, BL, BR				set
MDR350	350	WH, BL, BR				set
MDR400	400	WH, BL, BR				set
MDR450	450	WH, BL, BR				set
MDR500	500	WH, BL, BR				set
MDR550	550	WH, BL, BR				set
MDR600	600	WH, BL, BR				set

Clamp-on - 25kg Load rating
Tool available
Minimum buy 100 sets
1 Set = 1 Drawer

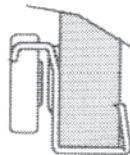

Part No.	Slide Length	Finish	Price 200	Price 100	per
MRCL350	350	WH, BR			set
MRCL400	400	WH, BR			set

*Other sizes available - Please enquire
Also available with knock-in dowels on
Carcase members - Please enquire*

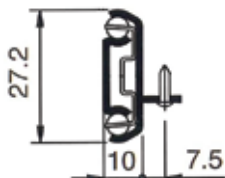

BALL BEARING SINGLE EXTENSION SLIDE

15kg Load rating
Bottom mounted
Detachable
1 Set = 1 Drawer

Part No.	Slide Length	Finish	Price 100	Price set	per
DSSE350	350	BL			set
DSSE400	400	BL			set
DSSE450	450	BL			set





BALL BEARING FULL EXTENSION SLIDES

Side mounted
45kg load rating
1 set = 1 drawer

Part No.	Slide Length	Finish	Price 60	Price 12	Price set	per
DS53250	250	ZP, BL				set
DS53300	300	ZP, BL				set
DS53350	350	ZP, BL				set
DS53400	400	ZP, BL				set
DS53450	450	ZP, BL				set
DS53500	500	ZP, BL				set
DS53550	550	ZP, BL				set
DS53600	600	ZP, BL				set

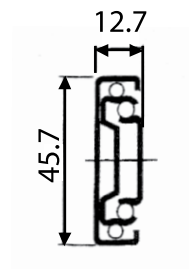

Bottom mounted - with tabs
45kg load rating
1 set = 1 drawer

Part No.	Slide Length	Finish	Price 60	Price 12	Price set	per
DS53B250	250	ZP, BL				set
DS53B300	300	ZP, BL				set
DS53B350	350	ZP, BL				set
DS53B400	400	ZP, BL				set
DS53B450	450	ZP, BL				set
DS53B500	500	ZP, BL				set
DS53B550	550	ZP, BL				set
DS53B600	600	ZP, BL				set

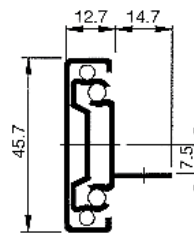

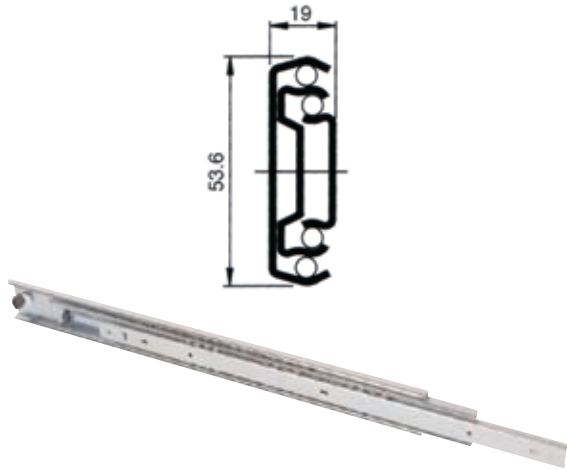

EUROTEK HEAVY DUTY SLIDES - 115kg

Full extension
Ball bearing - Side mounted
Heavy duty 115kg static load rating
1 Set = 1 Drawer

Part No.	Slide Length	Finish	Price 5	Price set	per
DS115550	550	ZP			set
DS115750	750	ZP			set
DS1151000	1000	ZP			set
DS1151200	1200	ZP			set

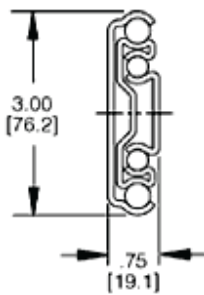

ACCURIDE SUPER HEAVY DUTY SLIDE - 250kg

Made in USA
Full extension - Ball bearing side mount
250kg Static load rating
Can be used with ACC9380 (below)

Part No.	Slide Length		Price ea	per
ACC9301.42R	1066	Right		ea
ACC9301.42L	1066	Left		ea
ACC9301.60R	1524	Right		ea
ACC9301.60L	1524	Left		ea

*Note - Price is for one slide only
2 Slides required per drawer*

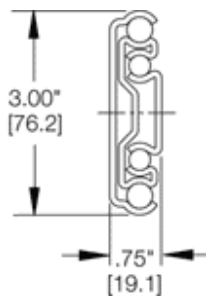

ACCURIDE SUPER HEAVY DUTY SLIDE-LOCKING - 250kg

Made in USA
Full extension - Ball bearing side mount
250kg Static load rating
Lock in & lock out
Can be used with ACC9301 (above)

Part No.	Slide Length		Price ea	per
ACC9308.42R	1066	Right		ea
ACC9308.42L	1066	Left		ea
ACC9308.60R	1524	Right		ea
ACC9308.60L	1524	Left		ea

*Note - Price is for one slide only
2 Slides required per drawer*



WIRE WARDROBE BASKET

- Powder coated steel
- Fits standard metal drawer slides - see page B.3

450mm x 390mm x 130mm

Part No.	Finish	Price 20	Price ea	per
WB010	WH			ea

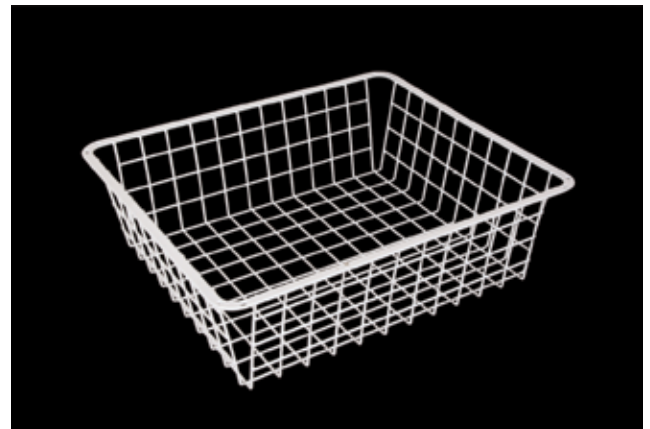

450mm x 390mm x 210mm

Part No.	Finish	Price 20	Price ea	per
WB020	WH			ea

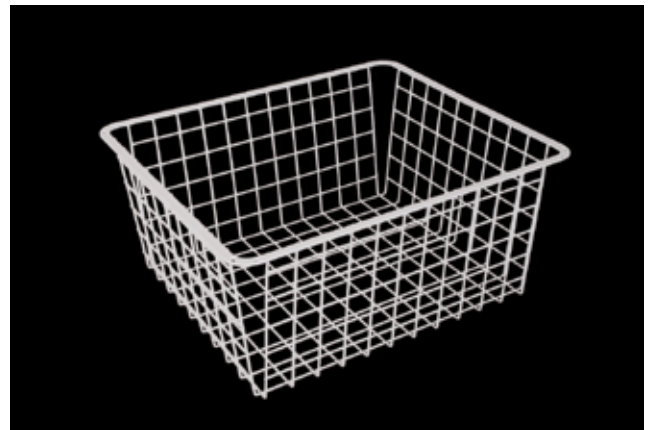

430mm x 330mm x 200mm

Part No.	Finish	Price 20	Price ea	per
WB005	WH			ea

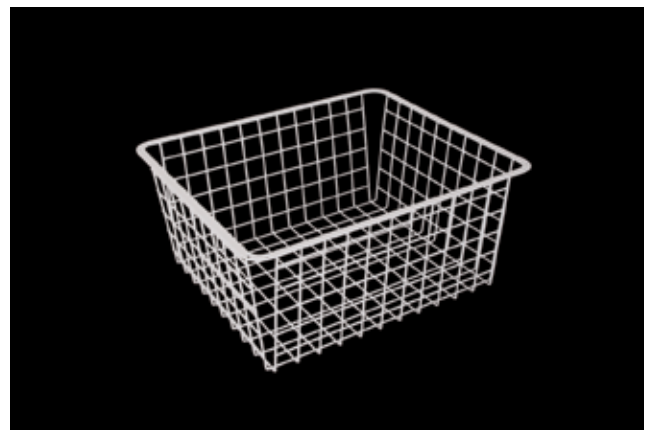

MEPLA ALFIT DYNAMIC NT



- Concealed full extension slide
- 40kg load rating
- Slide-on mounting
- Intergrated soft-close
- Front fix bracket with integrated height adjustment
- Made in Austria



1 Kit = Left slide, Right slide, Left bracket, Right bracket

Part No.	Price 20	Price 5	Price kit	per
AL7001.350 NT				kit
AL7001.400 NT				kit
AL7001.450 NT				kit
AL7001.500 NT				kit
AL7001.550 NT				kit



4 sided drawer

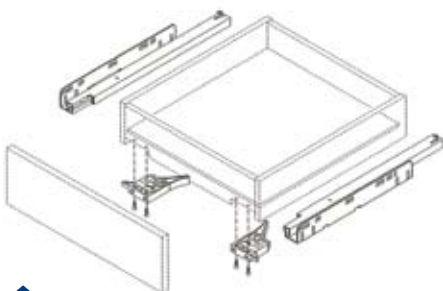

3 sided drawer

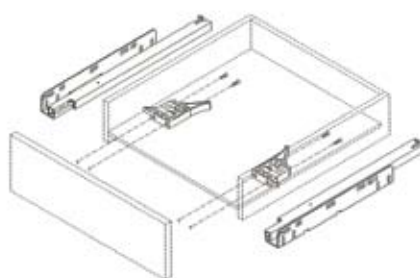

Inset drawer

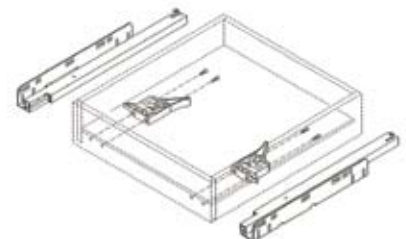



furnware
CABINET HARDWARE SPECIALISTS

Drawer Systems - Concealed Soft-Close Slide

Nominal length/NL	Drawer length	Min. installation depth
-------------------	---------------	-------------------------

350	340	350
400	390	400
450	440	450
500	490	500
550	540	550

Drawer



SK = Drawer length
NL = Nominal length of slide

Drawer cut outs and borings

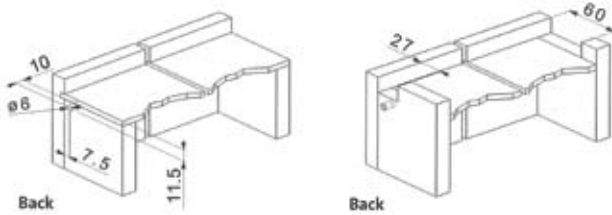

Inset drawer

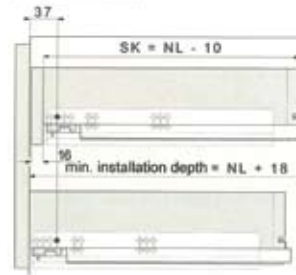

SK = Drawer length
NL = Nominal length of slide

Drawer installation measurements

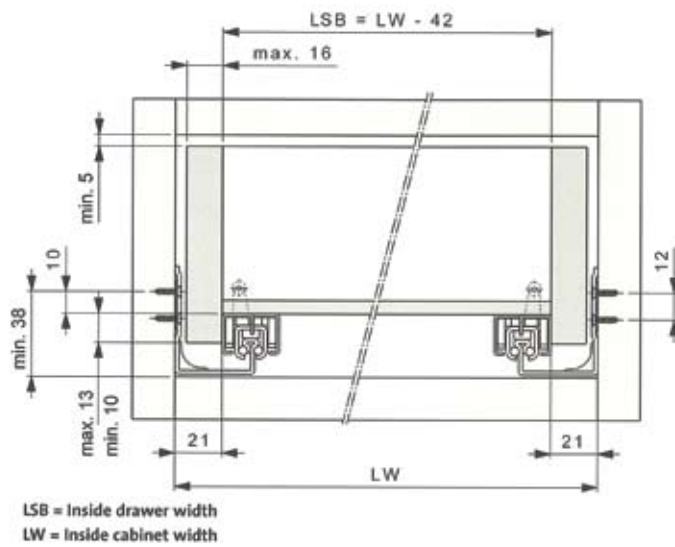

Cabinet fixing positions

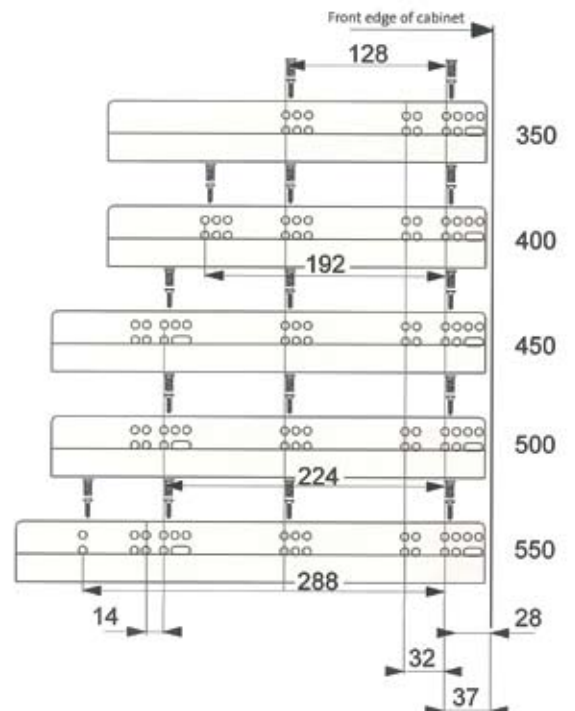



METAL WARDROBE DRAWER

- Cam adjustable drawer front
- Prefixed front brackets with 10mm dowels
- 25kg Load rating
- 400mm Drawer length only
- **Minimum quantity purchase 10 per size**



85mm High

Part No.	Finish	Price 100	Price 10	per
EKB400-85	WH			set



115mm High

Part No.	Finish	Price 100	Price 10	per
EKB400-115	WH			set



150mm High

Part No.	Finish	Price 100	Price 10	per
EKB400-150	WH			set



200mm High

Part No.	Finish	Price 100	Price 10	per
EKB400-200	WH			set

Please contact us for machinery options.





EUROTEK FILE RAILS

Side rails only for parallel files
Parts supplied shown in red

Part No.	Drawer Length	Finish	Price 10	Price set	per
EPF400	400	WH			set
EPF450	450	WH,BL			set
EPF500	500	WH,BL			set
EPF550	550	WH			set

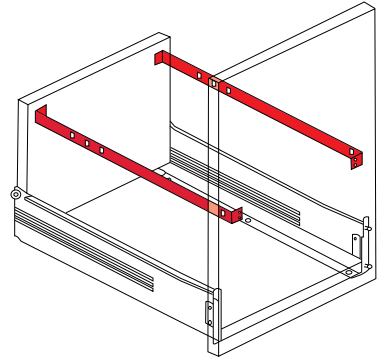

PLASTIC FILE GUIDE

To suit 12mm draw sides
2.4m Long

Part No.	Finish	Price 50	Price ea	per
FDG/2.4	WH			ea



ALUMINIUM ANGLE

12 x 12 x 2150mm

Part No.	Finish	Price 50	Price ea	per
AA12	ALU			ea



METAL ROD

1/4" x 1.8m Long

Part No.	Finish	Price 50	Price ea	per
MR14	RW			ea



Available cut to any length. Minimum qty 500pcs. Please enquire.

